



OWNER MANUAL

Cayman B / With GPS

Suitable For:
50736-12V/55lbs
50737-24V/80lbs



To The Owner

Thank you for selecting a Haswing electric outboard motor. It's designed for the purpose of superior performance, portability and environmental contribution. Enjoy using the Haswing Cayman B/with GPS!

This Owner's Manual contains important information pertaining to installation, correct operation and maintenance. Please read the manual before using this motor. If you have any questions contact your local Haswing distributor in the country of purchase.

★ We welcome comments regarding product improvement.

To avoid hazards and to obtain maximum performance and usage, special symbols are noted in this manual.



Failure to follow the instructions could cause severe injury.



Special precautions must be taken to avoid damage to the motor.



Information that makes the procedures easier and faster.

FOUR MARINE

Contents

Product features	2
Before operating	3
Installation	
❶ Installing the propeller	3-4
❷ Installing the fin	4
❸ Mounting the motor	5
❹ Battery connection	5
How to operate the motor	6-9
Audio Pattern	9
Trouble shooting	9
Maintenance	10
Electric Circuit Diagram	10
Package contents	17

**Read this page
before install**

FOUR MARINE

Product features

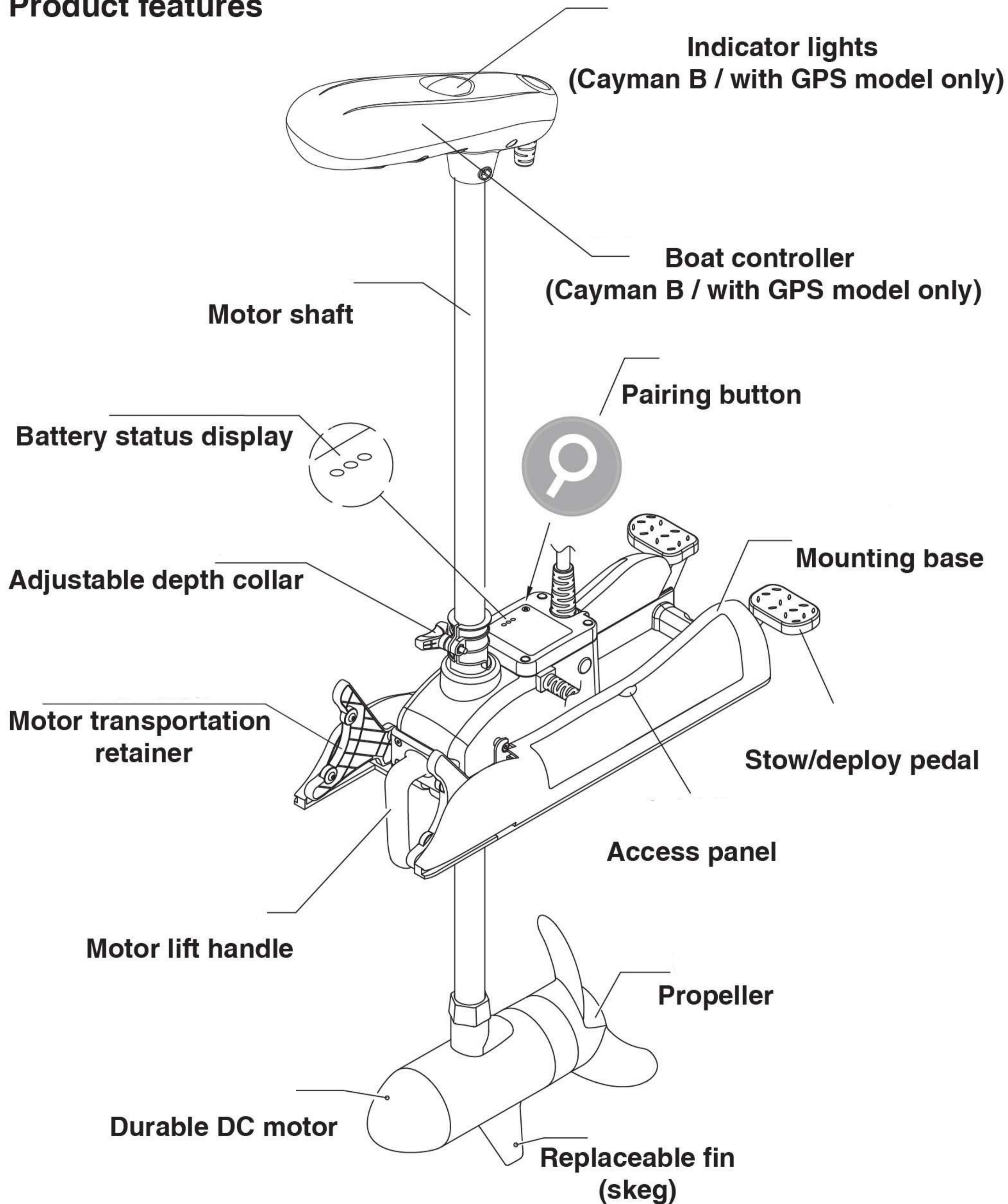

We reserve the right to change parts without notice.

Before operating the motor

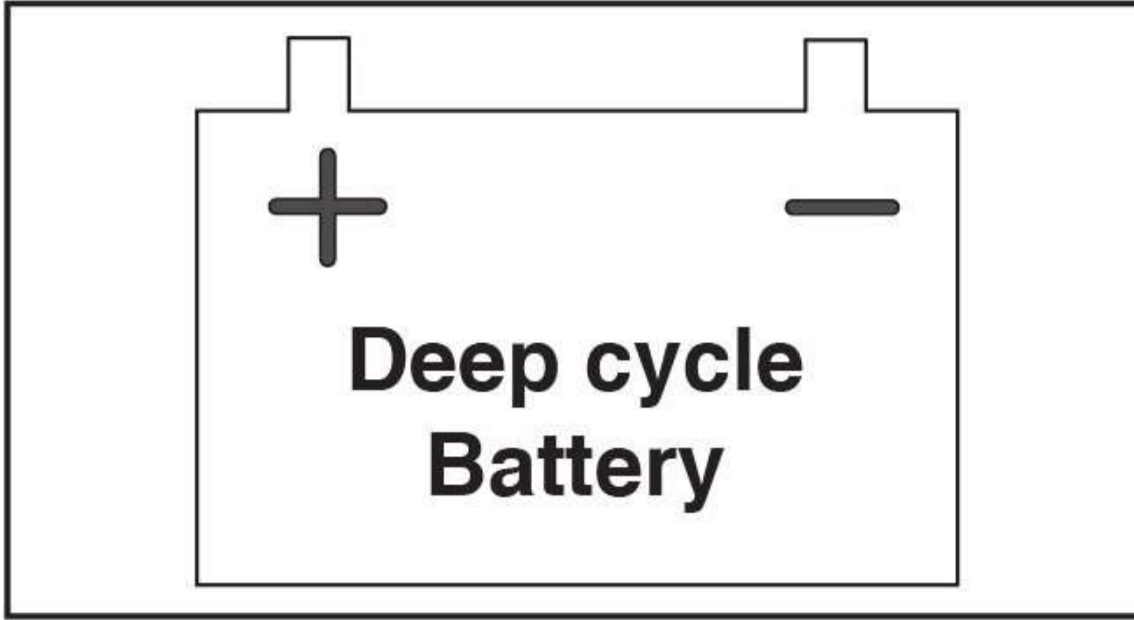

Only use deep cycle battery or batteries to power the motor. Incorrect or improper use, or connection of the battery could cause damage to the motor. Disconnect the battery when stowing the boat or not using for an extended period.

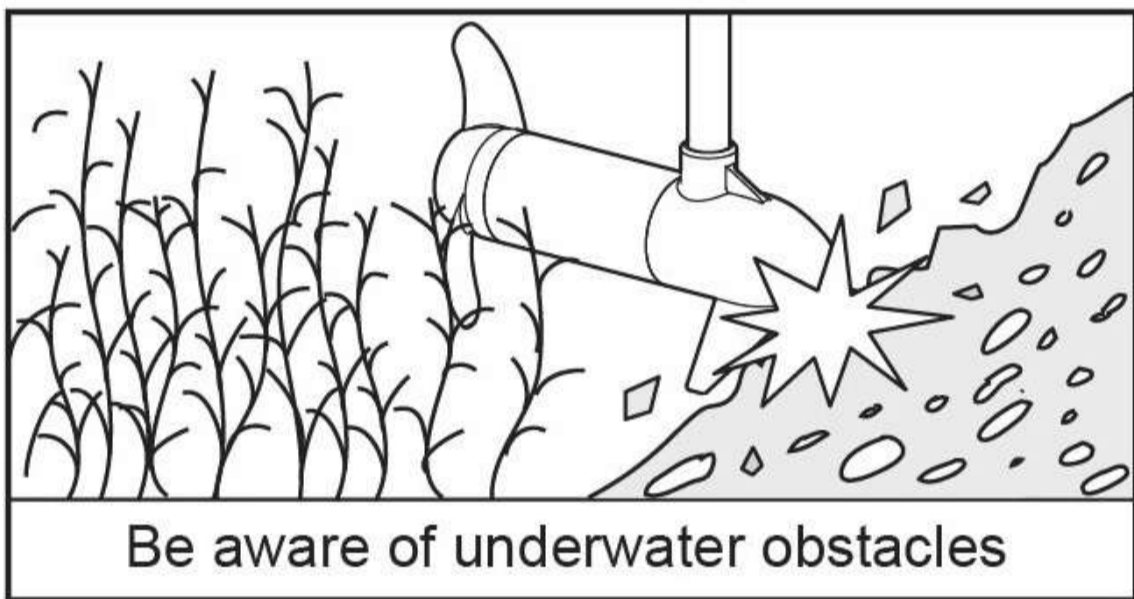

When motoring with the electric trolling motor in shallow water or around obstacles, reduce speed. Raise or retract the motor when in shallow water. Be aware of swimmers in close proximity to your vessel.

CAUTION IP68 waterproof level for the motor
IP63 waterproof level for all but the motor

1 Propeller installation

1. Install the drive pin (drive pin and cross-shaped slot in the propeller must align in order to correctly fit the propeller to the motor), anode, washer and self-locking nut onto the drive shaft. (Fig. 1)

NOTE The cross-shaped slot (2 slots) allow the user to re-assemble the propeller if one slot is worn.

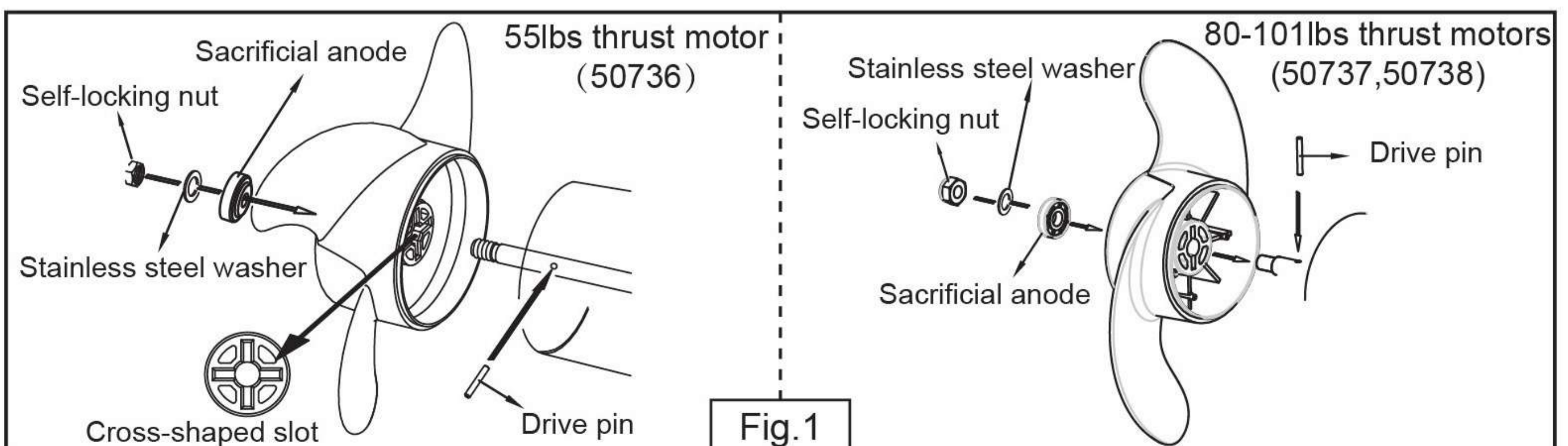
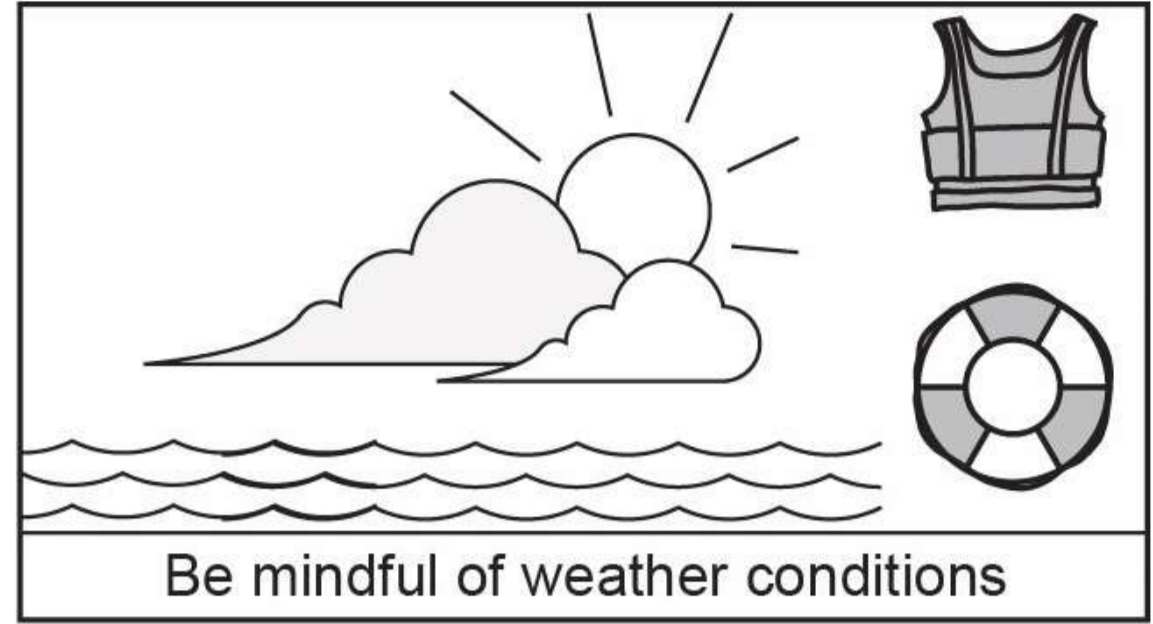
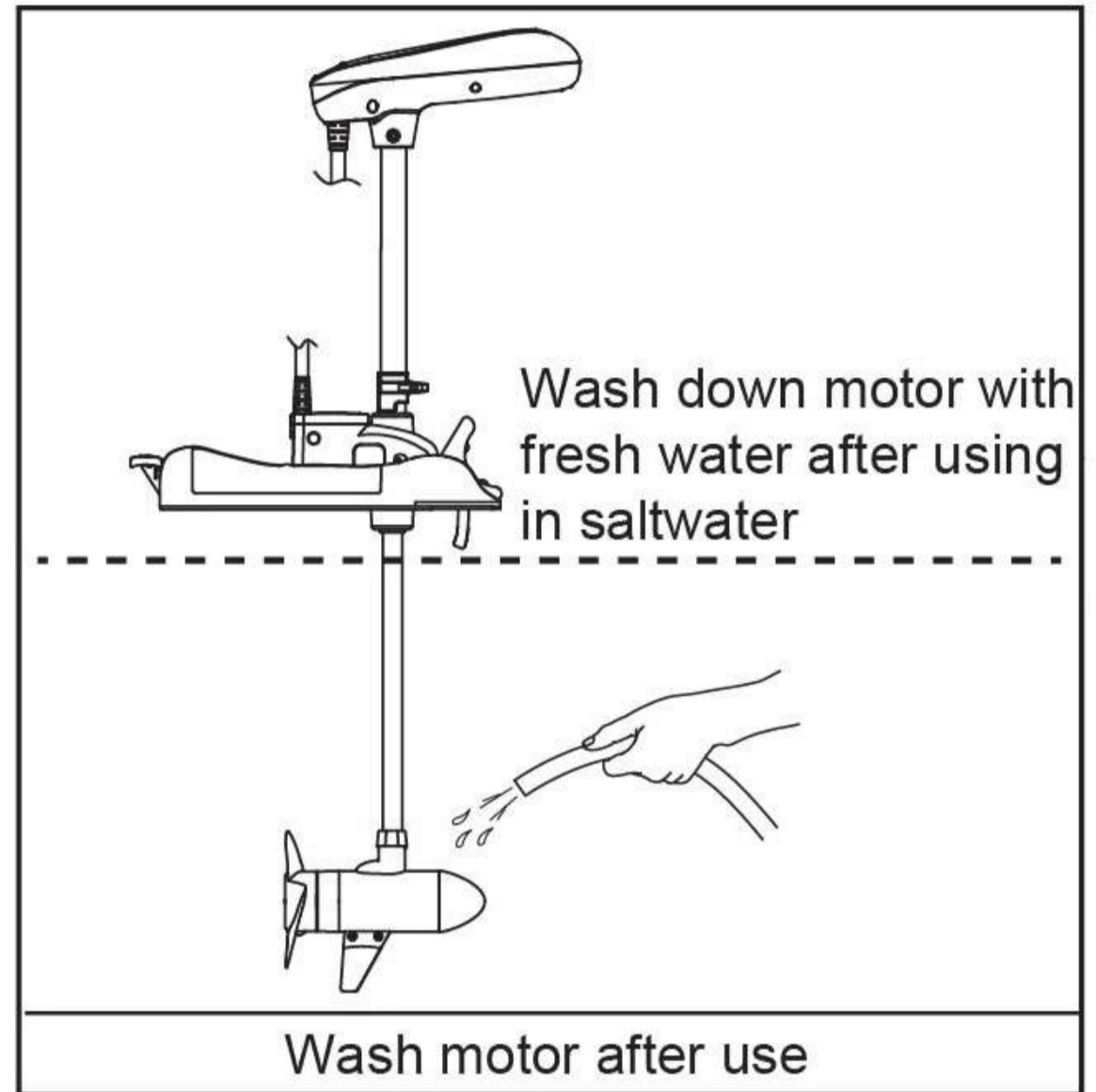

Fig. 1



Always wear an approved life vest or PFD (personal flotation device) and comply with local boating regulations.



Remove any debris from around the propeller or propeller drive shaft. Wash with freshwater after using in saltwater.

2. Hold the propeller to prevent it from rotating and use the propeller wrench to tighten the propeller nut until firm. Do not over-tighten. (Fig. 2)

NOTE Only use the supplied propeller wrench to tighten, other tools may cause over-tightening resulting in damage. TIP: Keep this hand wrench in your boat in the event that you get debris such as fishing line around the propeller shaft.

CAUTION Tighten the nut 1/4 turn past the 'snug' point. Over-tightening can cause damage to the propeller.

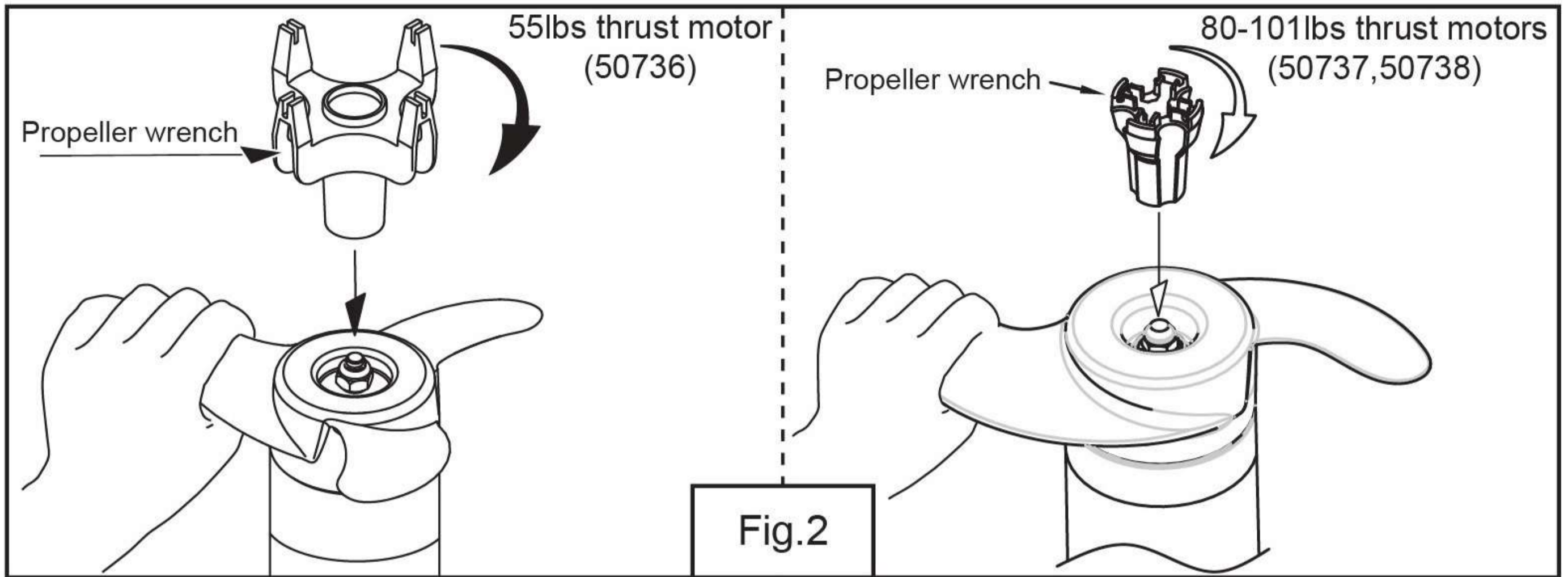

2 Installing the lift handle and fin

WARNING Ensure that the motor is disconnected from the battery before installing components.

NOTE Nuts, bolts and fin supplied in plastic bag.

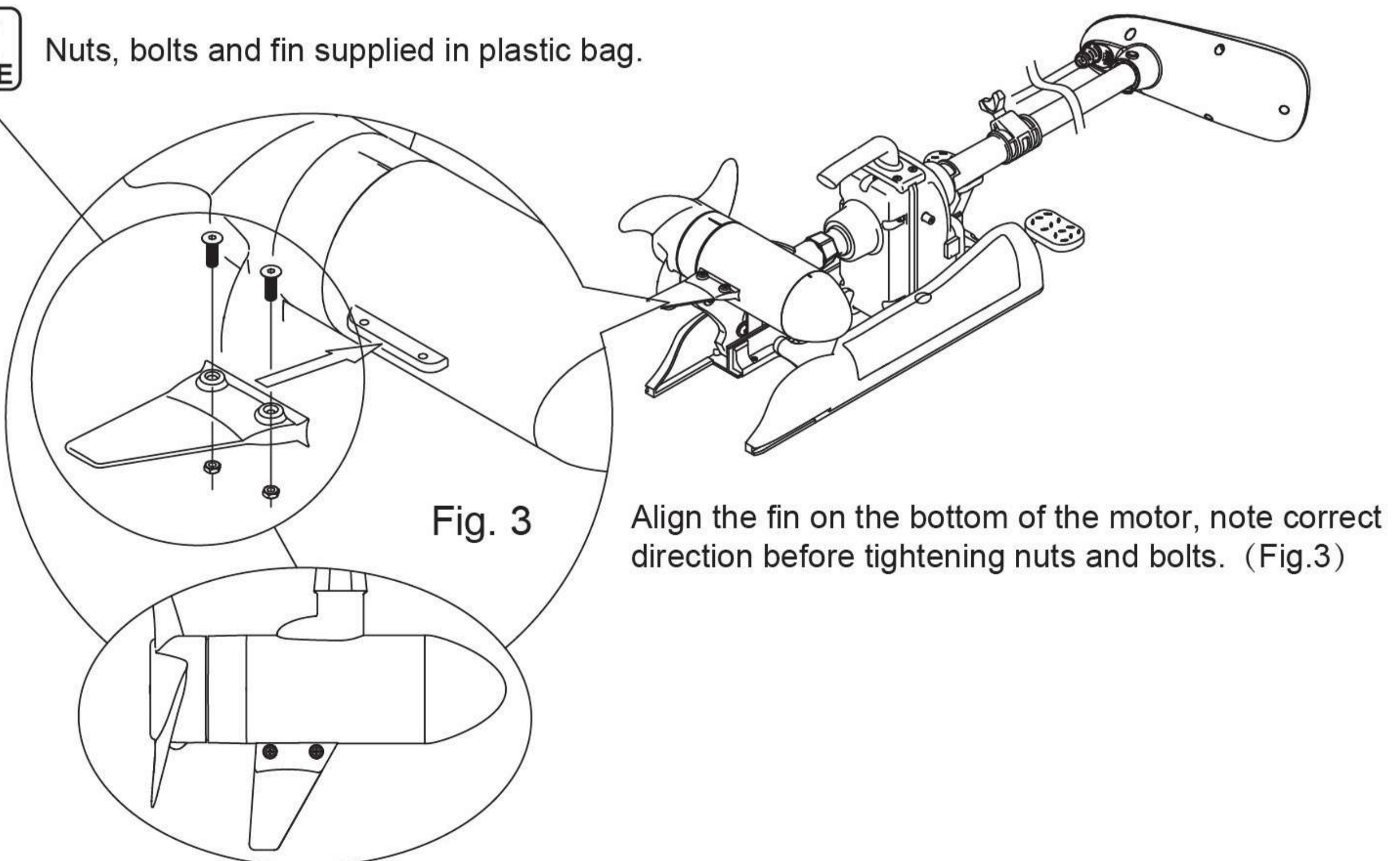

3 Mounting the motor

WARNING Ensure that the battery is not connected when initially installing or when mounting the motor using the Quick Release Bracket. If not using the motor for extended period or when storing the vessel, disconnect the battery.

Installation method

The motor can be bolted directly to the boat OR if using the Quick Release Bracket, bolt the puck to the boat. It is recommended to mount the motor so it is longitudinal with the boat or on a slight angle. This will also depend whether your boat has an electric motor mounting plate. (Fig.4)

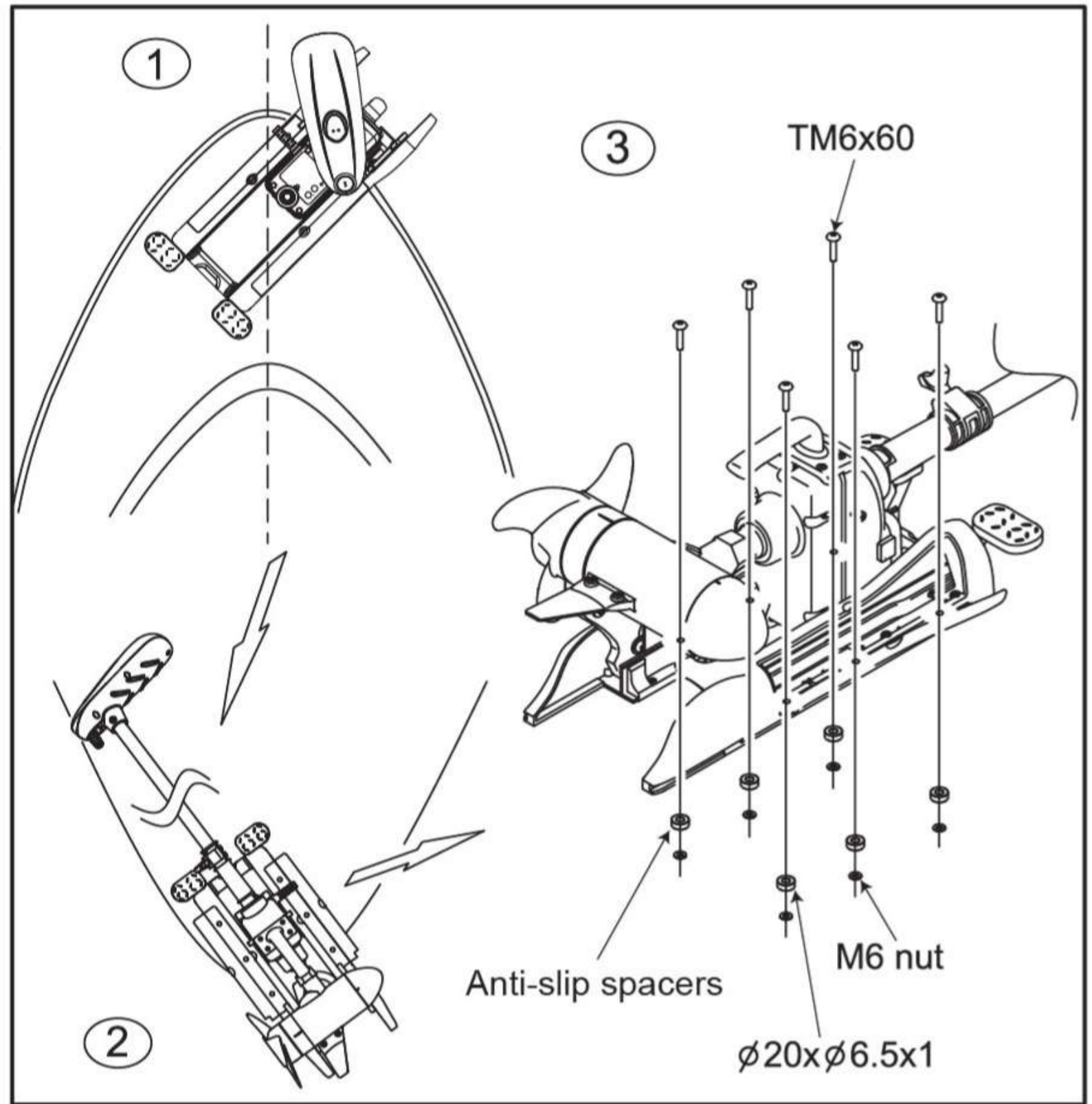

Fig.4

4 Battery connection

Only use a deep cycle battery of the correct voltage for the motor. Lead acid technology and lithium technology batteries are both suitable. Incorrect battery voltage or connection could damage the motor's electronics.

Connect the battery (+) to the positive (red) terminal, (-) to the negative (black) terminal. The ring connector should always be in the bottom most location with any washer sitting above the ring connector and then the nut.

(Fig. 5)

Always make sure that the battery or batteries are secured and free from contact with metal objects to prevent shorting out. A battery box is recommended. Lead acid technology batteries such as AGM may require ventilation.

WARNING

Always disconnect the motor from the battery when recharging the battery. Failure to do so could damage the motor's electronics.

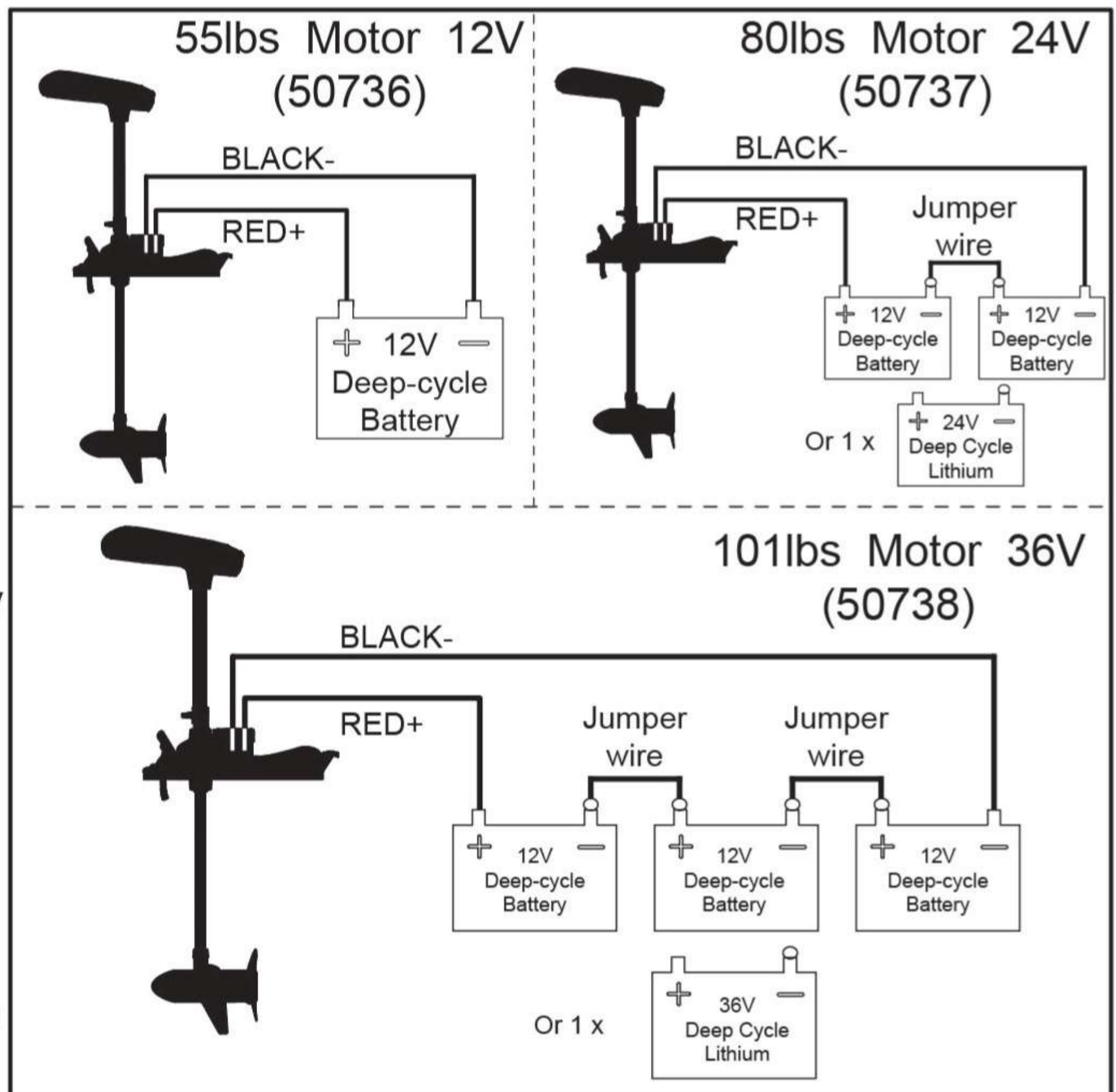

Fig.5

Correct operation of the motor

1. Deploying and stowing the motor

Deploying the motor

Press the stow/deploy foot pedal and gently lower the motor taking care to align the lower part of the Depth Collar with the Steering Collar. (Fig. 6)

Stowing the motor

Press the stow/deploy foot pedal, grab the handle, head or shaft of the motor, lift and retract, sliding back horizontally until the motor clicks into the cradle.

! WARNING When raising or lowering, keep fingers clear of all hinges and pivot points.

! WARNING The shaft of the Cayman slides smoothly making it easy to deploy and stow. Do NOT let the motor free-fall when deploying, but gently lower into position, otherwise damage can occur to the Steering Collar.

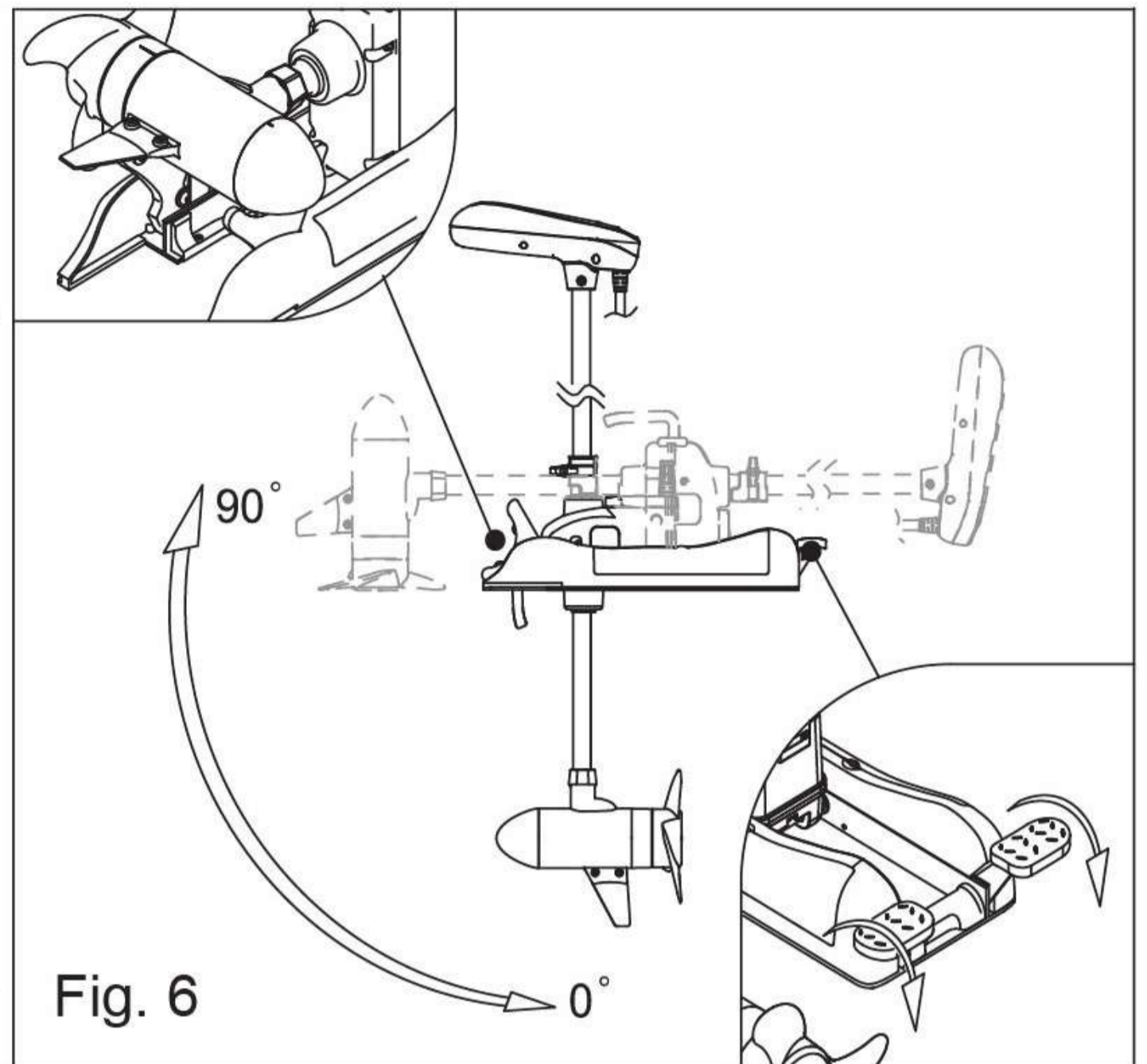

2. Adjusting the motor's depth

Whilst holding the motor by the shaft to prevent it from accidentally sliding, loosen the nut on the Depth Collar and lower the motor to the required depth. Tighten the nut to secure. (Fig. 7)

! WARNING

When towing the boat with the trolling motor in place, ALWAYS lock the Depth Collar against the gearbox and support the shaft near the head.

SUGGESTION

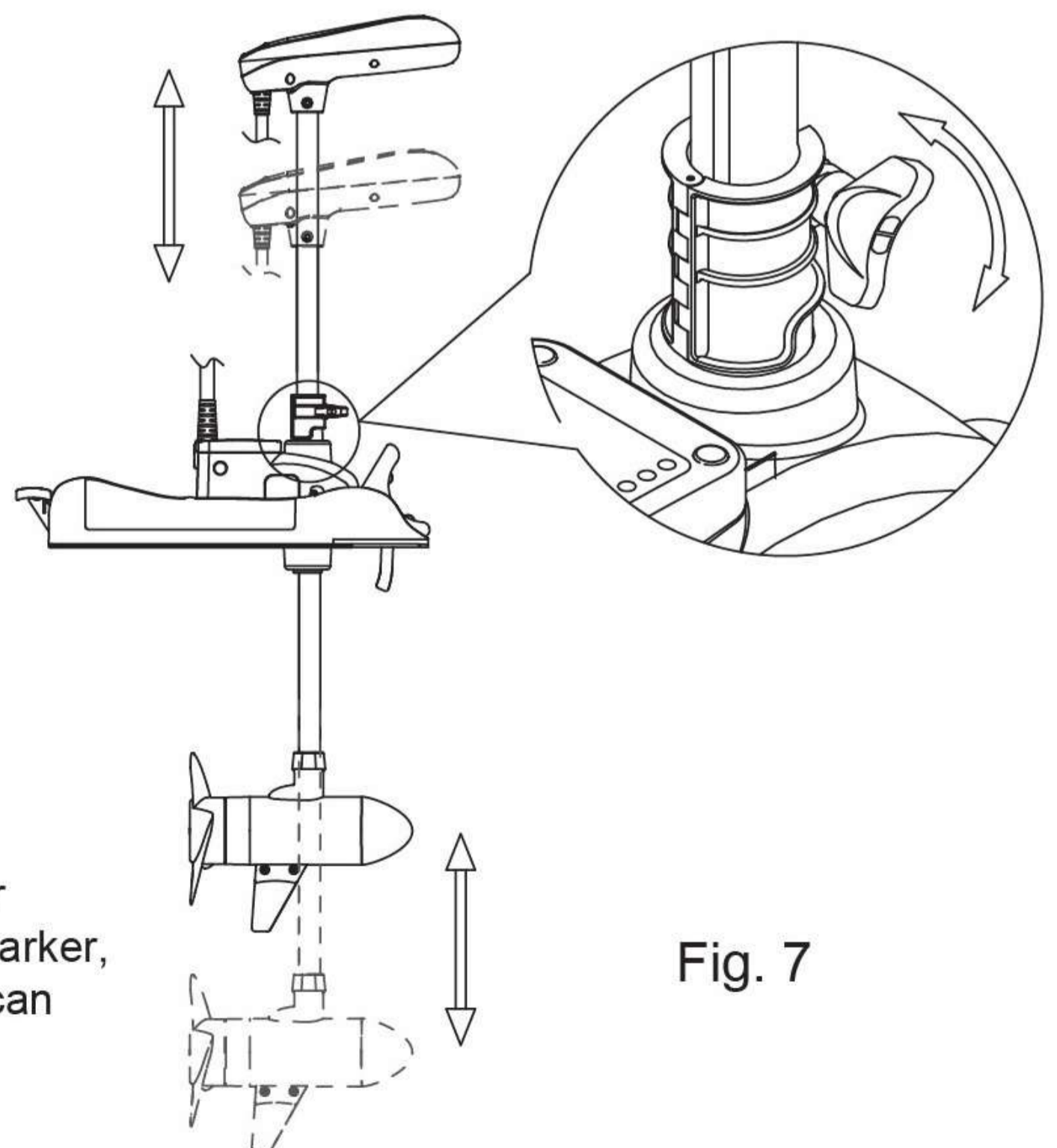

When first using the motor, find the correct depth for general fishing conditions and using a permanent marker, place a mark at the top of the Depth Collar so you can easily set the depth when you next go fishing.

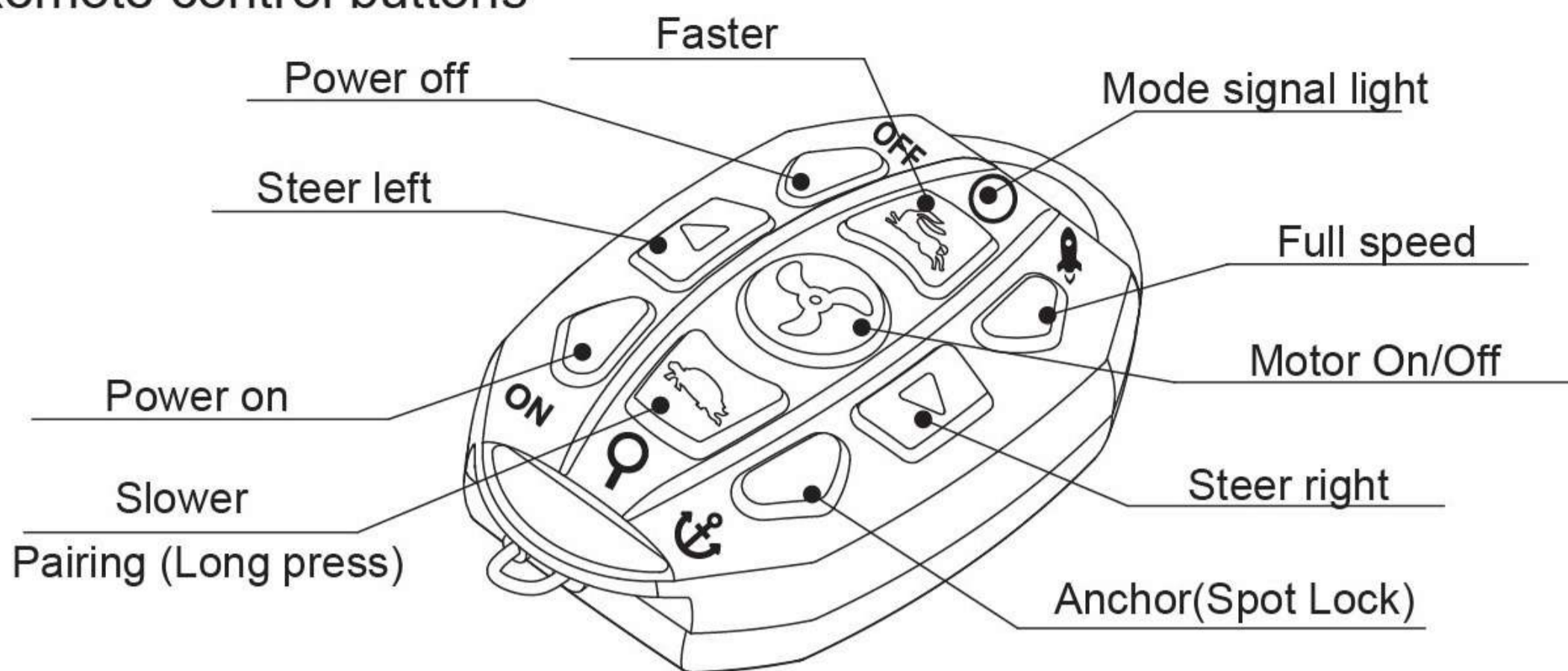

3. Remote control buttons



4. Pairing remote to motor

Press and hold  below the battery status lights on the motor (Fig. 8) and  (also the Slower button) on the remote at the same time for three (3) seconds or until you hear 3 beeps indicating that connection has been made and the remote and motor are paired. Release fingers from both buttons.

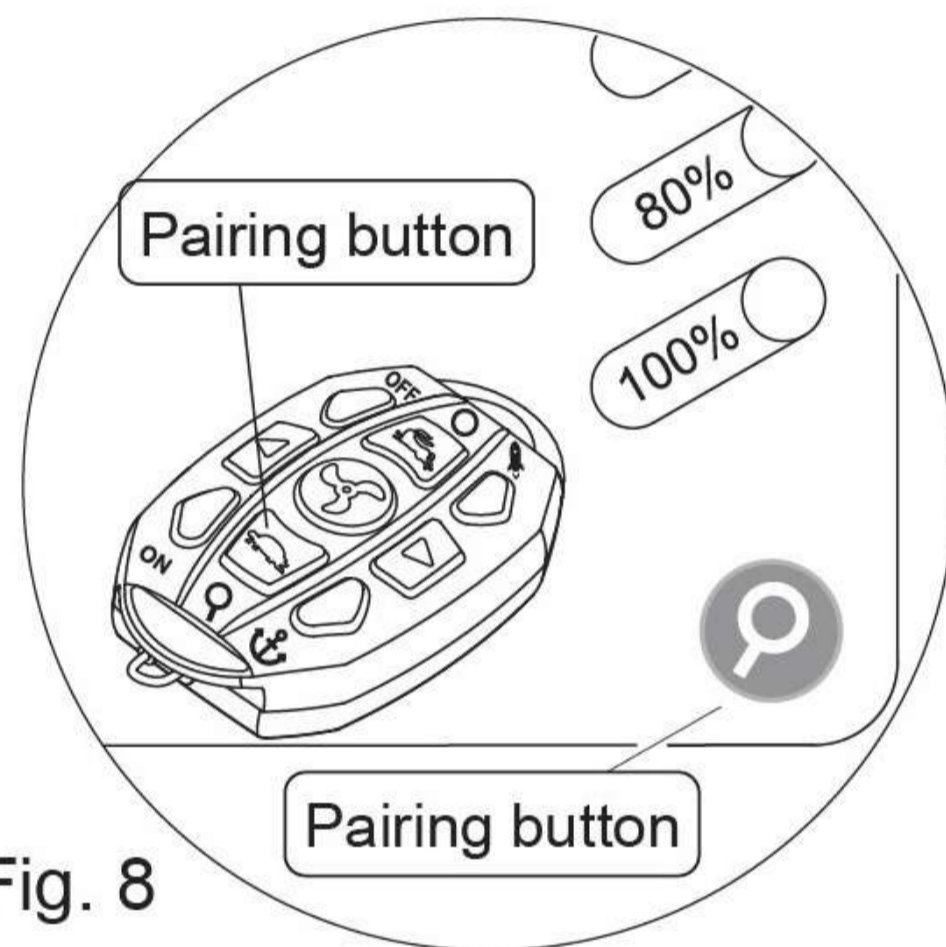



Fig. 8

5. Mode signal light

1. Press the "ON" button, indicator light is on solid or flashes, remote control is on "standby" state.
2. Press any button on the remote control, red indicator light flashes, indicating signal is sending.
3. Select  button, light is two-tone pink/purple, indicating motor is in the anchor (spot lock) mode.
4. Press "OFF" button to turn of remote control. Light is now off. (Fig. 9)

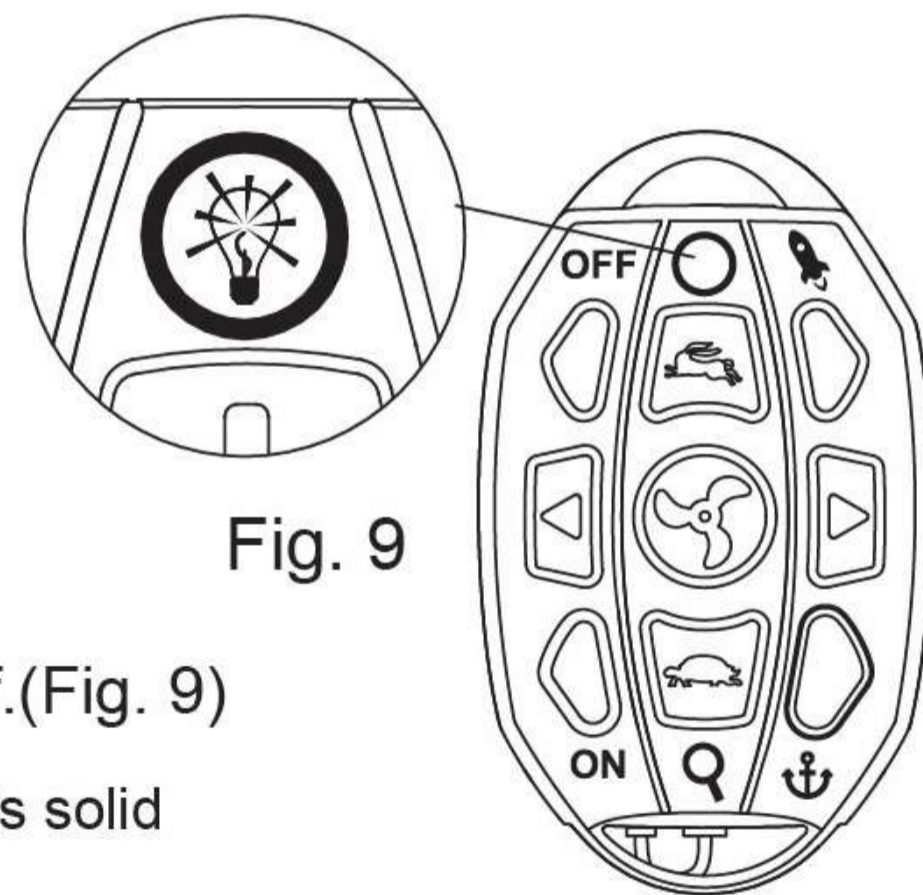





Fig. 9

NOTE If your press the "ON" button and there is no indicator light or is solid red, please recharge the remote control as the battery is flat.

6. Speed control

Press  to activate the motor. Press  or  to adjust the motor's speed. To stop the motor, press  to cancel. (Fig. 10)

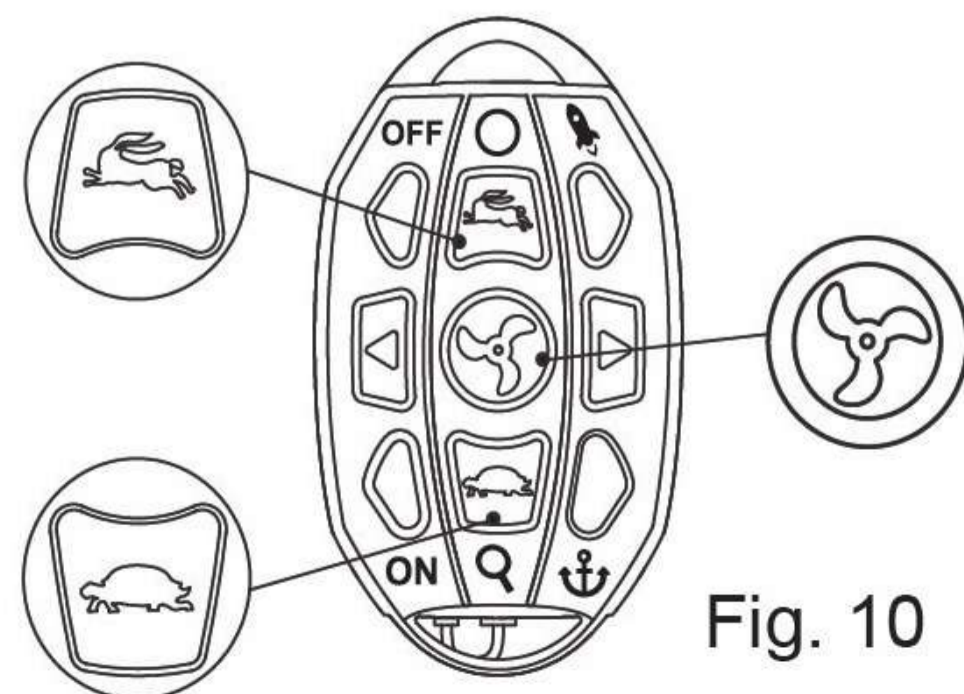

Fig. 10

7. Steering control

Press  or  to steer the motor direction left or right. (Fig. 11)

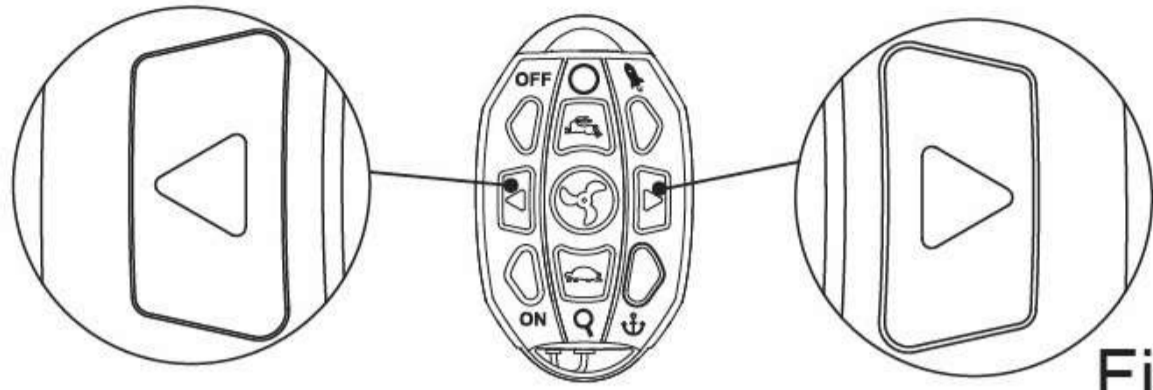



Fig. 11

8. Full speed

Press  to select full speed (turbo mode). Press again to return to the prior speed setting. (Fig. 12)

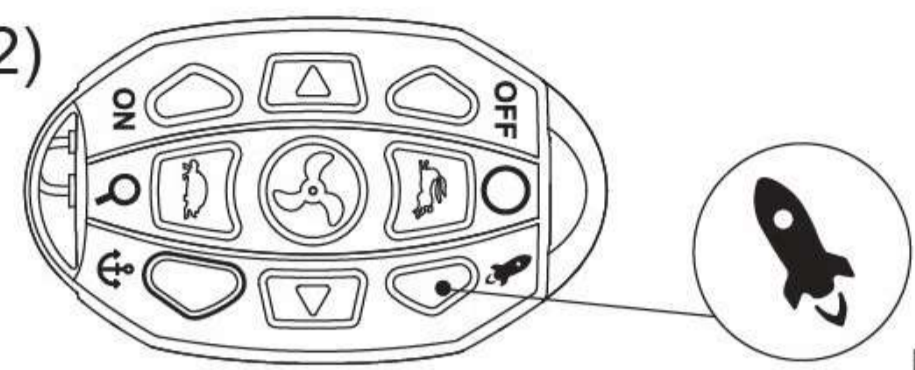





Fig. 12

9. Spot lock (anchor mode)

Press  to select spot lock (anchor) function to anchor the boat in position. Press  again to disengage anchor function, will return the motor to the stop mode. Press  and  to select speed. (Fig. 13)

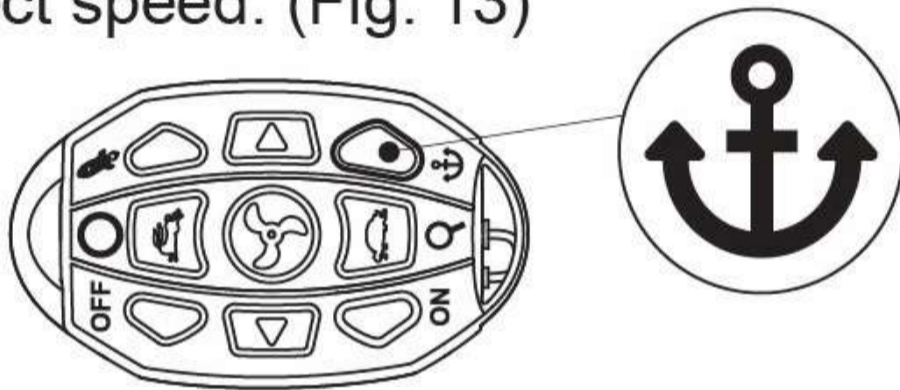

Fig. 13

10. Lanyard

For your convenience the lanyard can be configured to suit your preference ie around the neck or use the carabiner to clip to a belt loop. (Fig. 14)

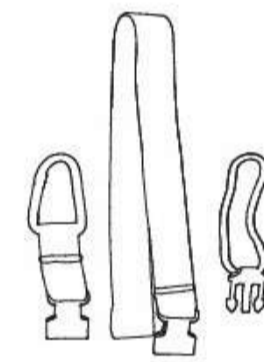

Fig. 14

11. Charging the remote

1. To charge the remote, remove the waterproof plug, connect the USB charging cable. The USB end of the cable has a charging status light - red light indicates charging, green light indicates charged.

NOTE: When charging the hand remote for the firsttime, the light will turn green fairly quickly, leave it charging overnight or for several hours. Only ever use the charging cable supplied with the remote, use of an incorrect cable can damage the battery and electronics of the remote.

2. The hand remote can on average be used continuously for 48 hours. You can have the remote plugged into a USB charging port (if your vessel has one fitted) and still use the remote to command the Cayman motor. (Fig. 15a)

3. If you want, you can **buy** your item: #59915 DC Adapter (as Fig. 15b) to charge the remote and smartphone. (Fig. 15c)

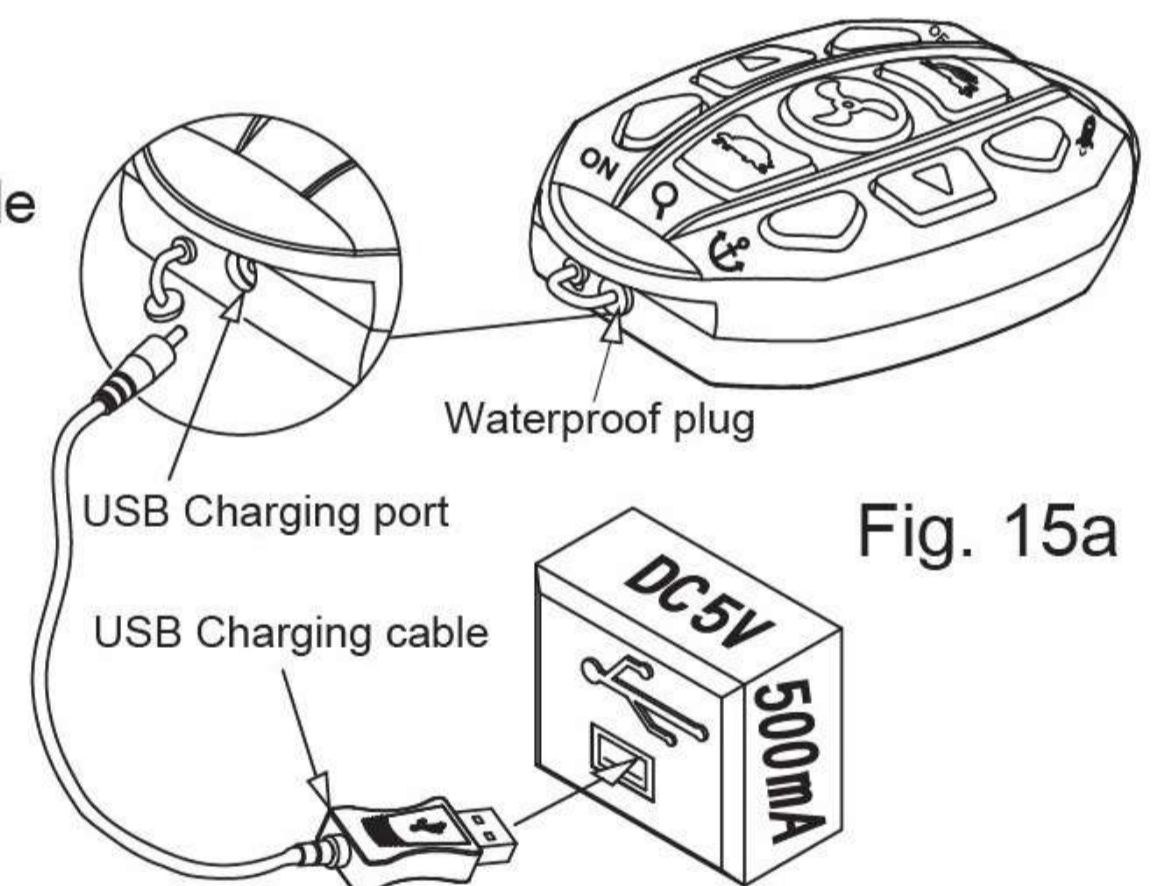

Fig. 15a

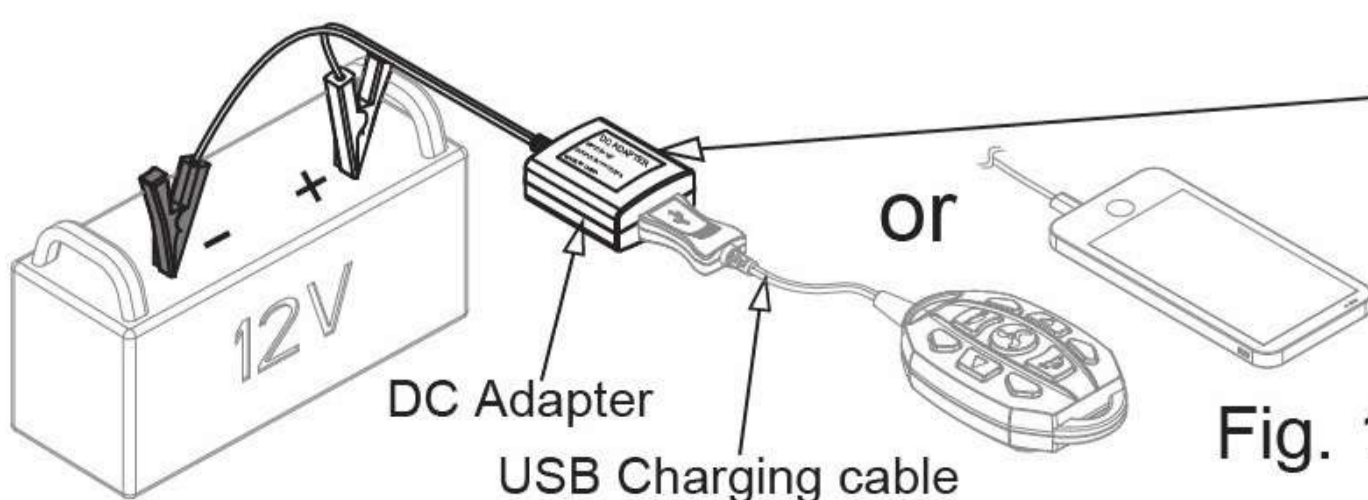

Fig. 15c

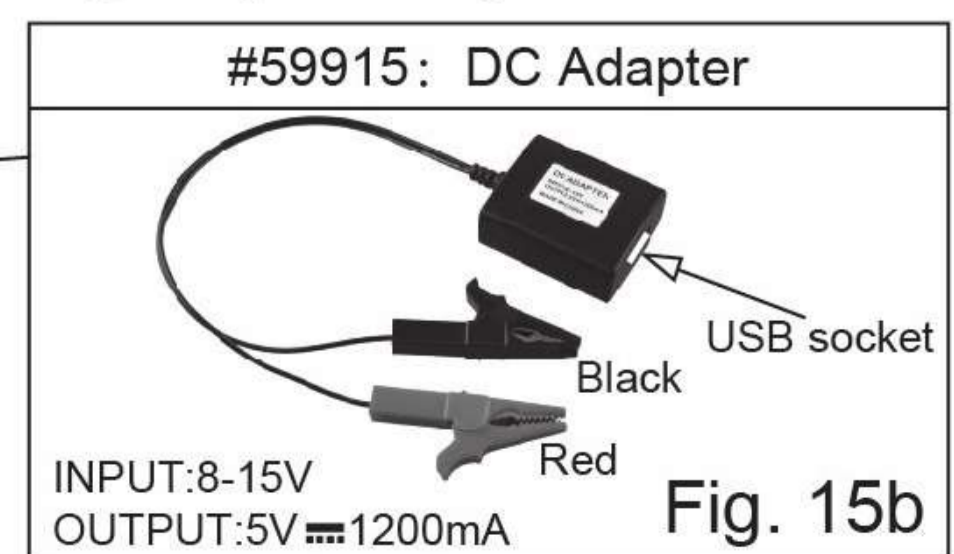

Fig. 15b

12. Battery Status Display

The motor has a Battery Status Display (3 LED lights) to show the charge status of the battery being used to power the Cayman motor. As the voltage of the battery discharges, the status light percentage will decline accordingly. It is highly recommended that you recharge the battery once it reaches 20% for lead acid technology batteries. Lithium batteries contain a BMS (battery management system) that actively manages the battery and when it reaches its maximum depth of discharge (DoD) the battery will automatically shut off. (Fig. 16)

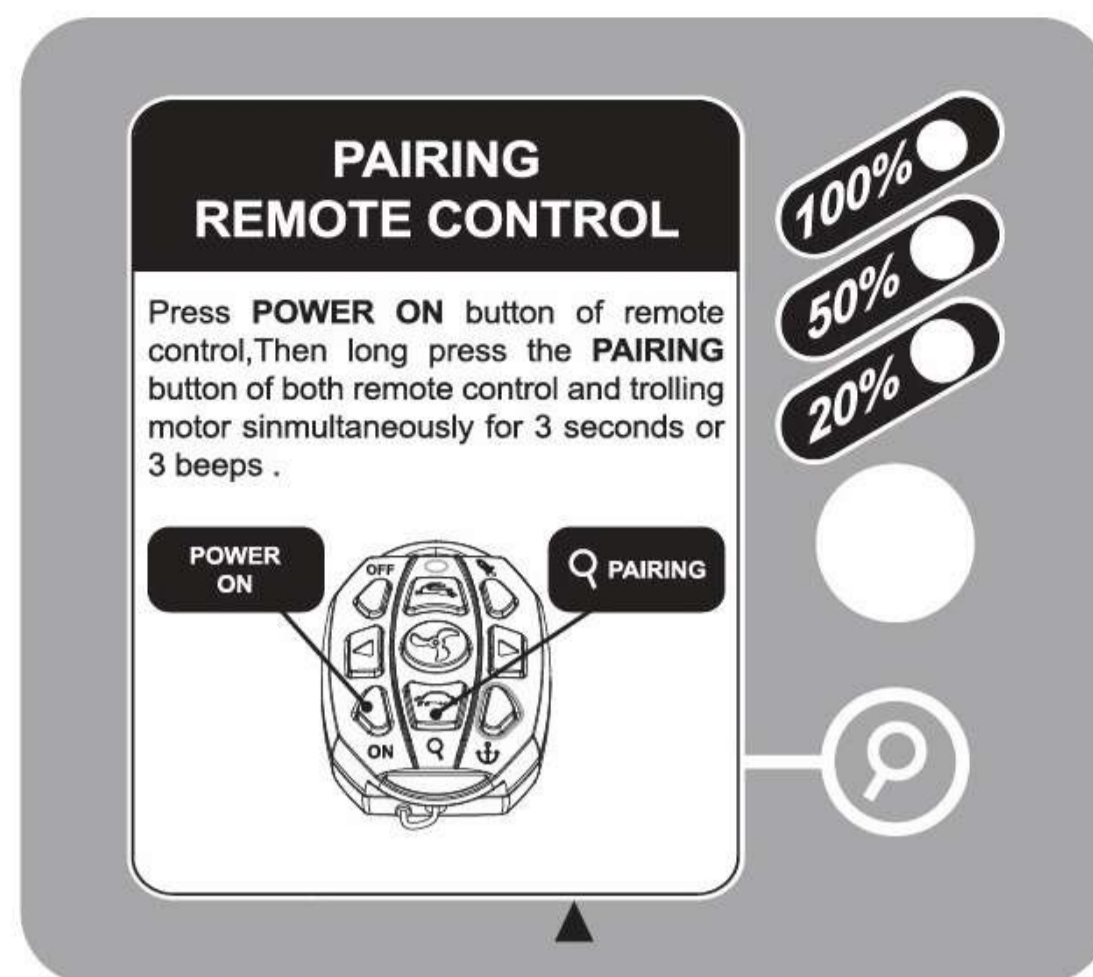

Fig. 16

When used with lithium batteries the battery status display is not entirely accurate due to the nature of discharge of lithium battery technology.

Trouble shooting

Audio Warning Pattern

1. Motor fails to run or lack of power

Make sure that the power cable from the battery is connected correctly.

Check that the terminals are clean and corrosion free.

Make sure that the battery is full. If flat or low voltage, please recharge.

Make sure that there is no fishing line or weeds caught up in the propeller. Please detach and clean up the propeller if there is debris got caught up inside the propeller. Warning - Make sure the motor is disconnected from the battery.

★ Make sure that the propeller drive pin is in good condition.

AUDIO PATTERN	STATUS
One (1) beep	Operation signal
Two (2) beeps	Function terminated or returned to the original setting
Three (3) beeps	Pairing successful
Five (5) beeps	System ready
Continuous	Low battery warning
Continuous long beep	Current overload

★ For all other malfunctions not listed above, please contact Haswing customer service center.

2. Motor vibration

Make sure that the propeller is installed correctly. Inspect the propeller and the drive/shear pin condition and if necessary, replace worn or faulty part.

Disconnect the battery cable and examine the motor by manually turning the propeller. The propeller should turn freely with some magnetic resistance. If there is strong resistance, there may be internal damage. If locked up or excessive resistance, please contact our customer service or the dealer.

3. Operation error warning signal

A continuous beep indicates a power output overload. It can happen if the motor is trying to propel a vessel of too greater weight capacity or has weed or fishing line has caught up under the propeller around the propeller or drive spline.

When the voltage of the battery is too low, the motor will shut off automatically to help protect

Maintenance

1. Wash and clean the motor and propeller thoroughly after use, especially after use in saltwater. Whilst the motor is manufactured for use in saltwater, proper care and maintenance is highly recommended to ensure years of trouble-free operation. Improper use or surface corrosion is not covered by warranty. (Refer page 3)
 2. Remove any debris such as weed from around the propeller or propeller drive shaft after every use. (Refer page 3 "Cleaning Motor")
 3. Apply suitable lubricant to the turning parts regularly and use the correct tools to fasten parts if required.
 4. Regularly apply corrosion prevention spray to help protect your motor.
 5. Store the motor in a dry, well ventilated place. The motor can be stored in almost any position, as there is not fuel to worry about leaking.
 6. Do not crush or put heavy items on top of the motor.
 7. This product is designed for outdoor use only.
 8. This motor is designed for outdoor amusement only. Continuous long distance transport is not permitted.
-



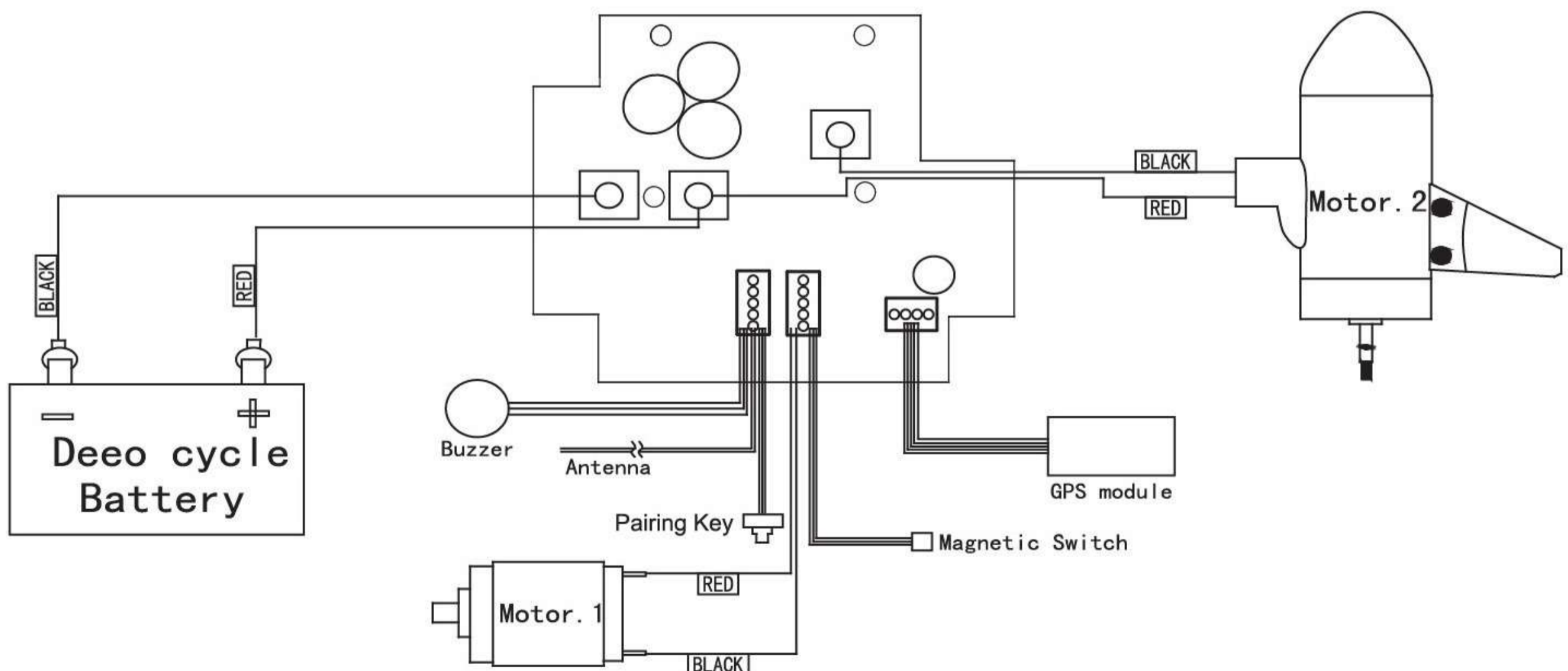



Electric Circuit Diagram

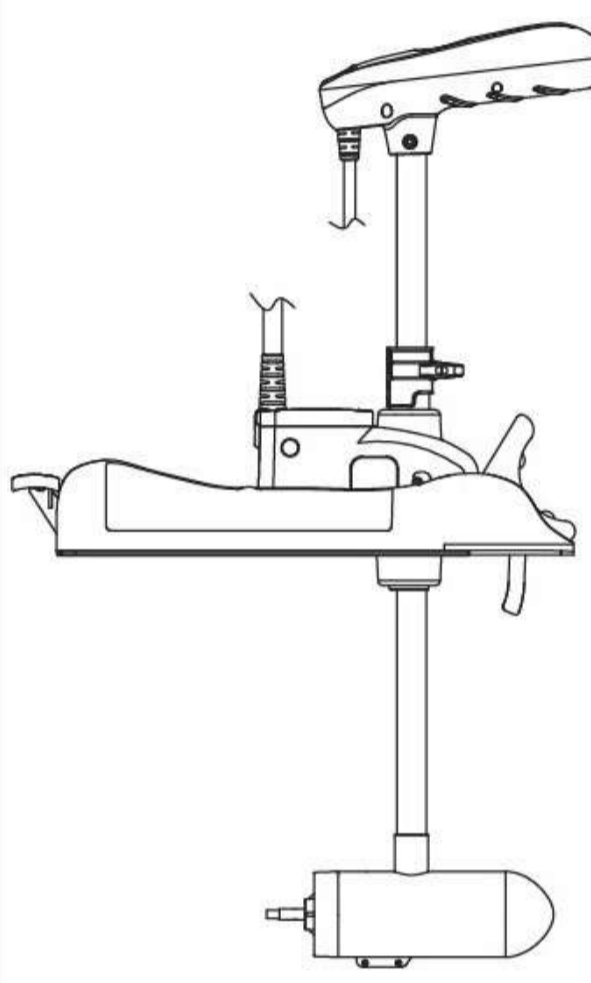

Packing List

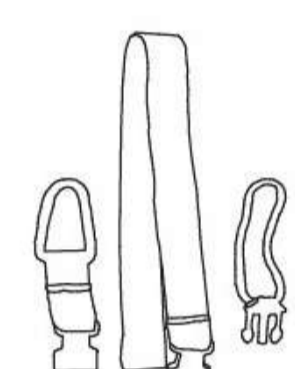
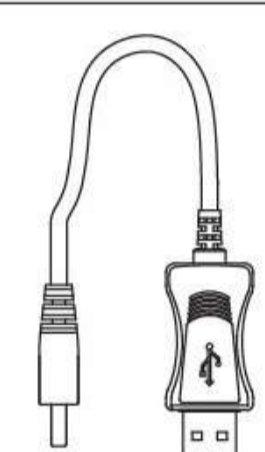
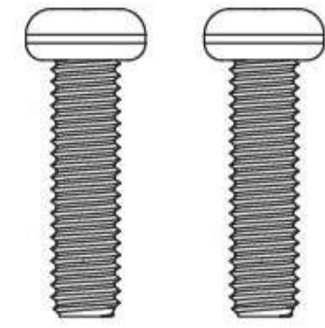
Model	50736 12V / 55lbs	50737 24V / 80lbs	50738 36V / 101lbs
Contents	2	2	2
	3	5	5
	1	4	6
		1	1

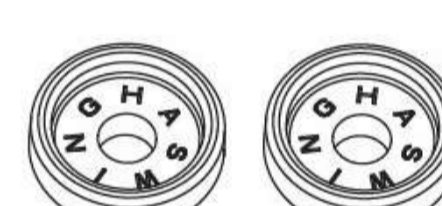
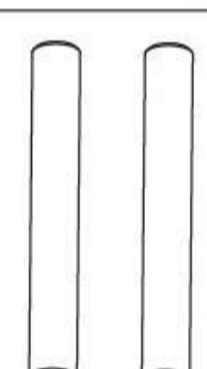
1	GPS
	GPS MANUAL
	
English version 1PCS	

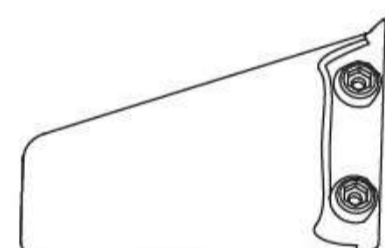
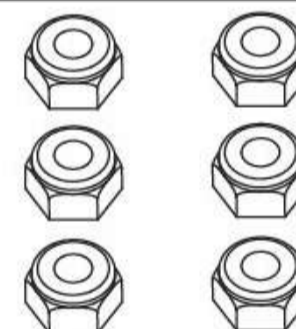
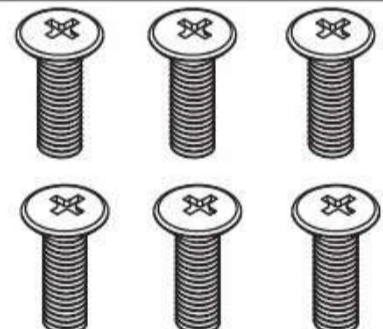
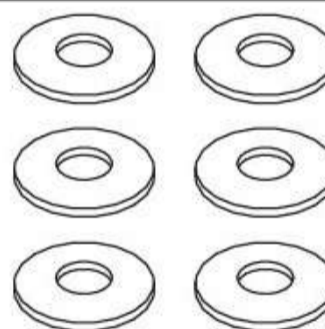
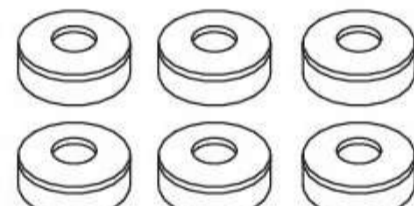
2	Trolling Motors	Wireless pocket remote	Slings	USB	PM4x14 螺丝
		 1PCS	 1PCS	USB Charging cable  1PCS	PM4x14 screws  2PCS
	OWNER'S MANUAL  1PCS	Sacrificial Anode  2PCS	Drive pin  2PCS	M4 M4 nuts  2PCS	
	Motor fin  1PCS	M6 M6 nuts  6PCS	TM6X60 TM6X60 screws  6PCS	Ø20XØ6.5X1 Ø20XØ6.5X1 Washer  6PCS	Motor anti-pulley  6PCS

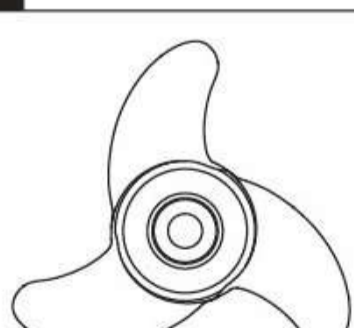
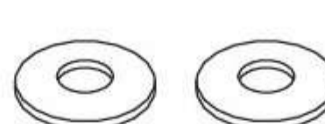
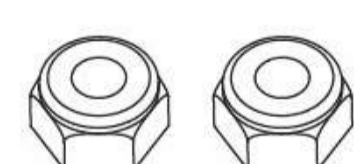
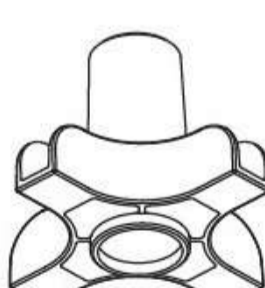
3	Propeller	Ø18XØ8.2X1 Ø18XØ8.2X1 Washer	M8 M8 nuts	Propeller Wrench	4 24V 24V Jumper wire
	 1PCS	 2PCS	 2PCS	 1PCS	

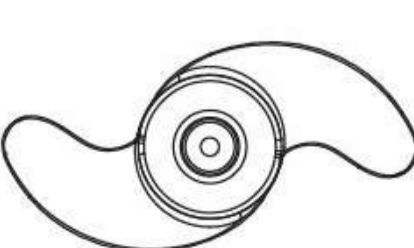
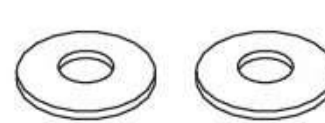
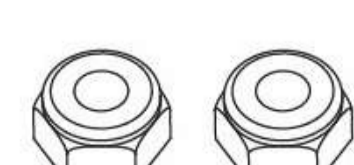
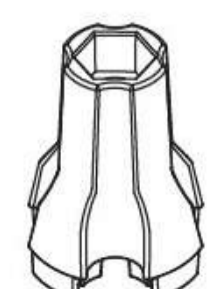
5	Propeller	Ø18XØ10.2X1 Ø18XØ10.2X1 Washer	M10 M10 nuts	Propeller Wrench	6 36V 36V Jumper wire
	 1PCS	 2PCS	 2PCS	 1PCS	



 **FOUR MARINE**

8χλμ. Θεσ/νίκης - Μουδανίων
Θεσσαλονίκη, 55510
2310 - 411245



www.fourmarine.gr